

POLY

9,5 kW

STUFA A PELLETT / PELLET STOVE



A+

VARIANTI COLORE / COLOUR VARIANTS / COLORIS / FARBVARIANTEN / VARIANTES COLOR / VARIANTES DE COR / BARVNE RAZLIČICE

 Bianco / White / Blanc / Weiss / Blanco / Branco / Bela

 Rosso / Red / Rouge / Rojo / Rot / Vermelho / Rdeča

 Nero / Black / Noir / Schwarz / Negro / Preto / Črna

DATI TECNICI / TECHNICAL DATA

- Modello: Poly
- Potenza bruciata: max 9,5 kW - min 2,8 kW
- Potenza resa in riscaldamento: max 8,0 kW - min 2,5 kW
- Classe ambientale: Prodotto a 5 stelle
- Classe di efficienza energetica: A+
- Rendimento: Pmax 88,0 % - Pmin 90,0 %
- Valore di CO con 13% di O₂: Pmax 0,010 % - Pmin 0,013 %
- Consumo pellet: max 2,0 kg/h - min 0,6 kg/h
- Capacità serbatoio: 13,5 kg
- Grandezza ambiente riscaldabile: 140 - 200 m³
- Distanze minime da pareti infiammabili: lato: 25 cm - retro: 10 cm - fronte: 100 cm
- Tensione alimentazione / frequenza: 230 V / 50 Hz
- Potenza nominale elettrica: 320 W
- Dimensioni: larghezza: 45,5 cm - profondità: 49,5 cm - altezza: 90,1 cm
- Peso: 58 kg
- Camera di combustione: Camera di combustione in acciaio
- Braciere: Braciere in acciaio inox
- Conforme alle norme: EN 14785 - BlmSchV II - 15a B-VG - LRV/VKF
- Scarico fumi: Superiore - Posteriore
- Display: 3 Tasti M
- Telecomando: Incluso
- Cassetto cenere: Cassetto cenere estraibile per recupero ceneri
- Modulo Wi-Fi per comando a distanza: Optional
- Pedana di protezione: Optional

DISEGNO TECNICO / TECHNICAL DRAWING

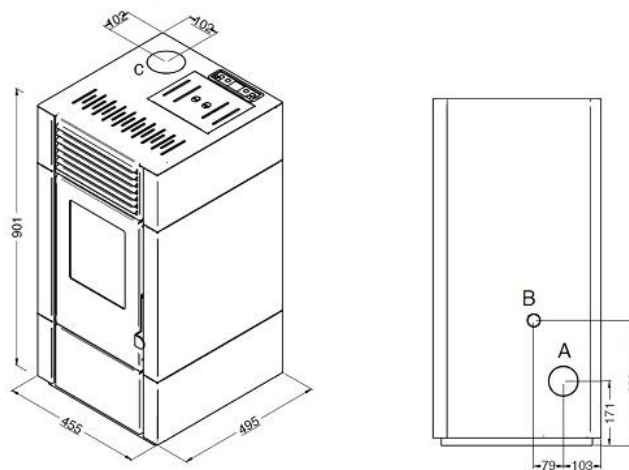

- A = Ø 80 mm Scarico fumi / Flue / Cheminée / Rauchabzug
Evacuación de humos / Descarga de humos
- B = Ø 40 mm Aria combustione / Combustion air / Air de combustion /
Verbrennungsluft / Aire para la combustión / Ar de combustão
- C = Ø 80 mm Scarico fumi superiore / Top Flue outlet / Sortie de Haut de Fumée /
Top Abgasstutzen / Salida humos superior / Descarga de humos posterior

EVA STAMPAGGI S.r.l. a socio unico

Via Cal Longa, 7/D - Z.I.
31028 - Vazzola (TV), Italia
Tel. +39 0438 740433 r.a.
Fax +39 0438 740821
R.I. TV, Cod. Fisc e P. IVA: 01183110269 - R.E.A. TV: 146443
Cap. Sociale € 100.000 i.v. - Società soggetta a direzione e coordinamento di We Four S.r.l.

e-mails: info@evastampaggi.com
info@evacalor.it
info@puntofuoco.net
info@montegan.it

websites: www.evastampaggi.com
www.evacalor.com
www.puntofuoco.net
www.montegan.it